



UP56-214128

UP56

LEVEL SENSORS

SICK
Sensor Intelligence.



Ordering information

Type	Part no.
UP56-214128	6048703

Other models and accessories → www.sick.com/UP56



Detailed technical data

Features

Medium	Fluids, bulk solids
Measurement	Switch, Continuous
Measuring range in tank	350 mm ... 3,400 mm
Measuring range immersion tube	350 mm ... 8,000 mm
Process pressure	0 bar ... 6 bar Gauge pressure
Process temperature	-25 °C ... +70 °C

Performance

Accuracy of sensor element	≤ 2 % ¹⁾
Reproducibility	± 0.15 % ¹⁾
Resolution	≤ 0.18 mm
Response time	≤ 240 ms ²⁾
MTTF	> 100 years

¹⁾ From the full scale value.

²⁾ Recovery time 32 ms ... 180 ms according to EMC EN 60947-5-7.

Electronics

Supply voltage	9 V DC ... 30 V DC ¹⁾
Residual ripple	± 10 %
Power consumption	≤ 80 mA ²⁾
Protection class	III
Connection type	Round connector M12 x 1, 5-pin
Output signal	1 x PNP + 4 mA ... 20 mA / 0 V ... 10 V ^{3) 4)}
Hysteresis	50 mm

¹⁾ Reverse-polarity protected.

²⁾ At 24 V DC without output load.

³⁾ Short-circuit protected, reversible.

⁴⁾ Automatic switching between voltage and current outputs dependet on load 4 mA ... 20 mA: RL ≤ 100 / at 9 V ≤ U_B ≤ 20 V; RL ≤ 500/ at U_B ≥ 20 V; 0 V ... 10 V: RL ≥ 100 k / at U_B ≥ 15 V, short-circuit protected.

Output current	200 mA
Time delay before availability	≤ 300 ms
Enclosure rating	IP67
Ultrasonic frequency	120 kHz
Ultrasonic transducer	PTFE coating, FFKM

¹⁾ Reverse-polarity protected.

²⁾ At 24 V DC without output load.

³⁾ Short-circuit protected, reversible.

⁴⁾ Automatic switching between voltage and current outputs dependet on load 4 mA ... 20 mA: RL ≤ 100 / at 9 V ≤ U_B ≤ 20 V; RL ≤ 500/ at U_B ≥ 20 V; 0 V ... 10 V: RL ≥ 100 k / at U_B ≥ 15 V, short-circuit protected.

Mechanics

Process connection	G 2 A PN 6
Housing material	Stainless steel 1.4571, FKM
Housing design	Standard
Weight	+ 1,200 g

Ambient data

Ambient operating temperature	-25 °C ... +70 °C ¹⁾
Ambient temperature, storage	-40 °C ... +85 °C

¹⁾ Temperature compensation at -25 °C ... +50 °C, can be switched off.

Classifications

ECLASS 5.0	27200506
ECLASS 5.1.4	27200506
ECLASS 6.0	27200506
ECLASS 6.2	27200506
ECLASS 7.0	27200506
ECLASS 8.0	27200506
ECLASS 8.1	27200506
ECLASS 9.0	27200506
ECLASS 10.0	27200506
ECLASS 11.0	27200506
ECLASS 12.0	27200506
ETIM 5.0	EC001447
ETIM 6.0	EC001447
ETIM 7.0	EC001447
ETIM 8.0	EC001447
UNSPSC 16.0901	41111950

Type code

Coverage

1	30 ... 250 mm
2	85 ... 350 mm
3	200 mm ... 1,300 mm

4	350 mm ... 3,400 mm
6	65 ... 700 mm
Connectivity	
1	M12 round connector x 1, 5-pin
2	M12 round connector x 1, 4-pin
Process connection / Housing	
1	G thread, stainless steel 1.4571 / plastic PBT, TPU, with display
2	G thread, stainless steel 1.4571 / stainless steel 1.4571, without display
4	GF connection D40, PTFE / plastic PP without display
5	GF connection D40, PTFE / plastic PP without display / short design (Mini)
7	G thread, PVDF / plastic PBT, TBU, with display
A	NPT thread, stainless steel 1.4571 / plastic PBT, TPU, with display
B	NPT thread, stainless steel 1.4571 / stainless steel 1.4571, without display
C	NPT thread, PVDF / plastic PBT, TPU, with display
Output function	
2	2 x PNP transistor output
4	2 x NPN transistor output
5	Push-pull: PNP/NPN; IO-Link 1.1 (process data, diagnostics, parameterization, data repository)
6	Analog, current output
8	Analog, current and voltage output + 1 PNP transistor output

UP 56 - 2 1 1

Not all variants of the type code can be combined!

[Dimensional drawing](#) (Dimensions in mm (inch))

UP56-214 all-metal

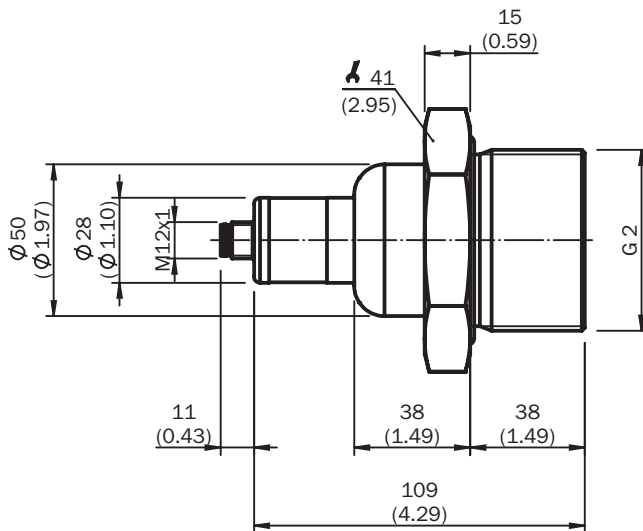

Connection diagram

1 x PNP + 4 mA ... 20 mA / 0 V ... 10 V

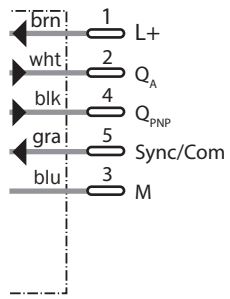

Connection type

Male connector M12, 5-pin



Scanning range

If the following destinations are located in the radiation cone, reliable detection is guaranteed.

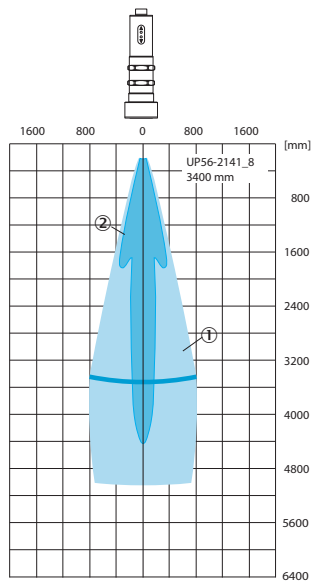





① Example object: aligned plate 500 mm x 500 mm

② Pipe diameter 10 mm

Recommended accessories

Other models and accessories → www.sick.com/UP56

	Brief description	Type	Part no.
Cloning modules			
	Tool for visualization, configuration and cloning, 3-digit LED display, supply voltage: DV 9 V ... 30 V	Connect+ adapter (CPA)	6037782
	<ul style="list-style-type: none"> • Connection type head A: Female connector, M12, 5-pin, straight, A-coded • Connection type head B: Flying leads • Signal type: Sensor/actuator cable • Cable: 2 m, 5-wire, PUR, halogen-free • Description: Sensor/actuator cable, unshielded • Application: Uncontaminated zones, Zones with oils and lubricants, Robot, Drag chain operation 	YF2A15-020UB5XLEAX	2095617
	<ul style="list-style-type: none"> • Connection type head A: Female connector, M12, 5-pin, straight, A-coded • Connection type head B: Flying leads • Signal type: Sensor/actuator cable • Cable: 2 m, 5-wire, PVC • Description: Sensor/actuator cable, unshielded • Application: Zones with chemicals, Uncontaminated zones 	YF2A15-020VB5XLEAX	2096239
	<ul style="list-style-type: none"> • Connection type head A: Female connector, M12, 5-pin, straight, A-coded • Connection type head B: Flying leads • Signal type: Sensor/actuator cable • Cable: 5 m, 5-wire, PUR, halogen-free • Description: Sensor/actuator cable, unshielded • Application: Uncontaminated zones, Zones with oils and lubricants, Robot, Drag chain operation 	YF2A15-050UB5XLEAX	2095618
	<ul style="list-style-type: none"> • Connection type head A: Female connector, M12, 5-pin, straight, A-coded • Connection type head B: Flying leads • Signal type: Sensor/actuator cable • Cable: 5 m, 5-wire, PVC • Description: Sensor/actuator cable, unshielded • Application: Zones with chemicals, Uncontaminated zones 	YF2A15-050VB5XLEAX	2096240
	<ul style="list-style-type: none"> • Connection type head A: Female connector, M12, 5-pin, straight, A-coded • Connection type head B: Flying leads • Signal type: Sensor/actuator cable • Cable: 10 m, 5-wire, PUR, halogen-free • Description: Sensor/actuator cable, unshielded • Application: Uncontaminated zones, Zones with oils and lubricants, Robot, Drag chain operation 	YF2A15-100UB5XLEAX	2095619
	<ul style="list-style-type: none"> • Connection type head A: Female connector, M12, 5-pin, straight, A-coded • Connection type head B: Flying leads • Signal type: Sensor/actuator cable • Cable: 10 m, 5-wire, PVC • Description: Sensor/actuator cable, unshielded • Application: Zones with chemicals, Uncontaminated zones 	YF2A15-100VB5XLEAX	2096241
	<ul style="list-style-type: none"> • Connection type head A: Female connector, M12, 5-pin, angled, A-coded • Connection type head B: Flying leads • Signal type: Sensor/actuator cable • Cable: 2 m, 5-wire, PUR, halogen-free • Description: Sensor/actuator cable, unshielded • Application: Uncontaminated zones, Zones with oils and lubricants, Robot, Drag chain operation 	YG2A15-020UB5XLEAX	2095772
	<ul style="list-style-type: none"> • Connection type head A: Female connector, M12, 5-pin, angled, A-coded • Connection type head B: Flying leads • Signal type: Sensor/actuator cable • Cable: 2 m, 5-wire, PVC • Description: Sensor/actuator cable, unshielded • Application: Zones with chemicals, Uncontaminated zones 	YG2A15-020VB5XLEAX	2096215

	Brief description	Type	Part no.
	<ul style="list-style-type: none"> • Connection type head A: Female connector, M12, 5-pin, angled, A-coded • Connection type head B: Flying leads • Signal type: Sensor/actuator cable • Cable: 5 m, 5-wire, PUR, halogen-free • Description: Sensor/actuator cable, unshielded • Application: Uncontaminated zones, Zones with oils and lubricants, Robot, Drag chain operation 	<p>YG2A15-050UB5XLEAX</p>	<p>2095773</p>
	<ul style="list-style-type: none"> • Connection type head A: Female connector, M12, 5-pin, angled, A-coded • Connection type head B: Flying leads • Signal type: Sensor/actuator cable • Cable: 5 m, 5-wire, PVC • Description: Sensor/actuator cable, unshielded • Application: Zones with chemicals, Uncontaminated zones 	<p>YG2A15-050VB5XLEAX</p>	<p>2096216</p>
	<ul style="list-style-type: none"> • Connection type head A: Female connector, M12, 5-pin, angled, A-coded • Connection type head B: Flying leads • Signal type: Sensor/actuator cable • Cable: 10 m, 5-wire, PUR, halogen-free • Description: Sensor/actuator cable, unshielded • Application: Uncontaminated zones, Zones with oils and lubricants, Robot, Drag chain operation 	<p>YG2A15-100UB5XLEAX</p>	<p>2095774</p>
	<ul style="list-style-type: none"> • Connection type head A: Female connector, M12, 5-pin, angled, A-coded • Connection type head B: Flying leads • Signal type: Sensor/actuator cable • Cable: 10 m, 5-wire, PVC • Description: Sensor/actuator cable, unshielded • Application: Zones with chemicals, Uncontaminated zones 	<p>YG2A15-100VB5XLEAX</p>	<p>2096217</p>

SICK AT A GLANCE

SICK is one of the leading manufacturers of intelligent sensors and sensor solutions for industrial applications. A unique range of products and services creates the perfect basis for controlling processes securely and efficiently, protecting individuals from accidents and preventing damage to the environment.

We have extensive experience in a wide range of industries and understand their processes and requirements. With intelligent sensors, we can deliver exactly what our customers need. In application centers in Europe, Asia and North America, system solutions are tested and optimized in accordance with customer specifications. All this makes us a reliable supplier and development partner.

Comprehensive services complete our offering: SICK LifeTime Services provide support throughout the machine life cycle and ensure safety and productivity.

For us, that is “Sensor Intelligence.”

WORLDWIDE PRESENCE:

Contacts and other locations –www.sick.com