

Datasheet

Suction cup F20 Silicone, G1/8" male, with mesh filter

Item number: F20.20.02AB



- Suitable for flat objects.
- Good stability and little inherent movement.
- Recommended when the lifting force is parallel to the surface of the object.
- Cleats prevent thin, sensitive objects from being deformed and gives extra friction when the lifting force is parallel.

Technical data

Description	Unit	Value
Suction cup shape	-	Flat
Application	-	Dry sheet metal
Suction cup design	-	Round
Characteristics	-	Dry sheet metal
Material	-	Silicone (SIL)
Weight, min.	oz	0.042
Suction cup model	-	F
Volume	in ³	0.061
Height	in	0.79
Outer diameter, min.	in	0.87
Outer diameter, actuated	in	0.91
Fitting size	-	1/8"
Fitting option	-	Filter mesh
Fitting style	-	Male
Fitting type	-	G-thread
Suction cup model	-	F20
Movement, vertical max.	in	0.047
Curve radius, min.	in	0.71

Performance - Lifting forces

F20	Vertical (lb)	Parallel (lb)
5.91 -inHg	1.35	1.12
17.72 -inHg	3.26	1.80
26.58 -inHg	4.27	1.91

Material	
Name	Silicone, SIL 50° Shore A
Color	Red
Temperature, min. °F	-40.0
Temperature max. °F	392.0
Hardness °Shore A	50

Material resistance

Alcohol	Good
Concentrated acids	Poor
Ethanol	n/a
Hydrolysis	Fair
Methanol	n/a
Oil	Poor
Oxidation	Excellent
Gasoline	Poor
Wear resistance	Good
Weather and ozone	Excellent

Dimensional drawings

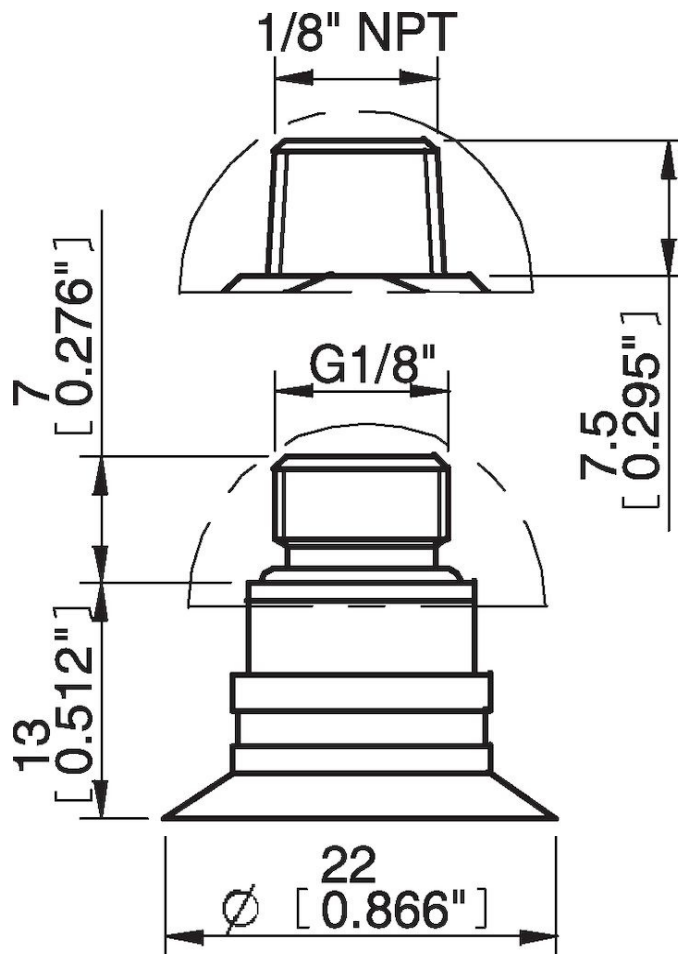

Values specified in this data sheet are tested at (unless otherwise stated):

- Room temperature (20°C [68°F] ± 3°C [5.5°F]).
- Standard atmosphere (101.3 [29.9 inHg] ± 1.0 kPa [0.3 inHg]).
- Relative humidity 20-70%.
- Compressed air quality, DIN ISO 8573-1 class 4.

Accessories

02AE | Fitting 5xM5 female

F20.10 | Suction cup F20 Chloroprene

02AF | Fitting G1/8" male/M5 female, with mesh filter

02CD | Fitting G1/8" male/M5 female, PA

02AA | Fitting M5 female

02AD | Fitting G1/8" male/M5 female

02AC | Fitting 1/8" NPT male, with mesh filter

02DA | Fitting M5 female, with dual flow control valve

02DC | Fitting 1/8" NPT male, with dual flow control valve

02DD | Fitting G1/8" male/M5 female, with dual flow control valve

02DE | Fitting 5xM5 female, with dual flow control valve

Spare parts

F20.20 | Suction cup F20 Silicone

02AB | Fitting G1/8" male, with mesh filter