

Vacuum switch, pneumatic, preset (NC 9.0 -inHg)

Item number: 31.16.087

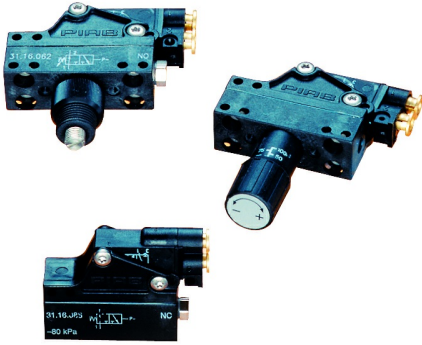

- Converts a vacuum level to a pneumatic signal.
- Vacuum-actuated membrane linked to a pneumatic switch.
- Available preset or with adjustable vacuum level.

Technical data

Description	Unit	Value
Material	-	Al, CuZn, Nitrile (NBR), PA, POM, SS
Temperature, max.	°F	140.0
Temperature, min.	°F	14.0
Weight, min.	oz	1.38
Feed pressure, max. (@ vacuum connection)	psi	0.087
Valve function	-	NC
Feed pressure, optimum, max.	psi	0.12
Feed pressure, optimum, min.	psi	0.022
Hysteresis	psi	1.74
Signal range, max.	-inHg	10.34
Signal range, min.	-inHg	7.38

Dimensional drawings

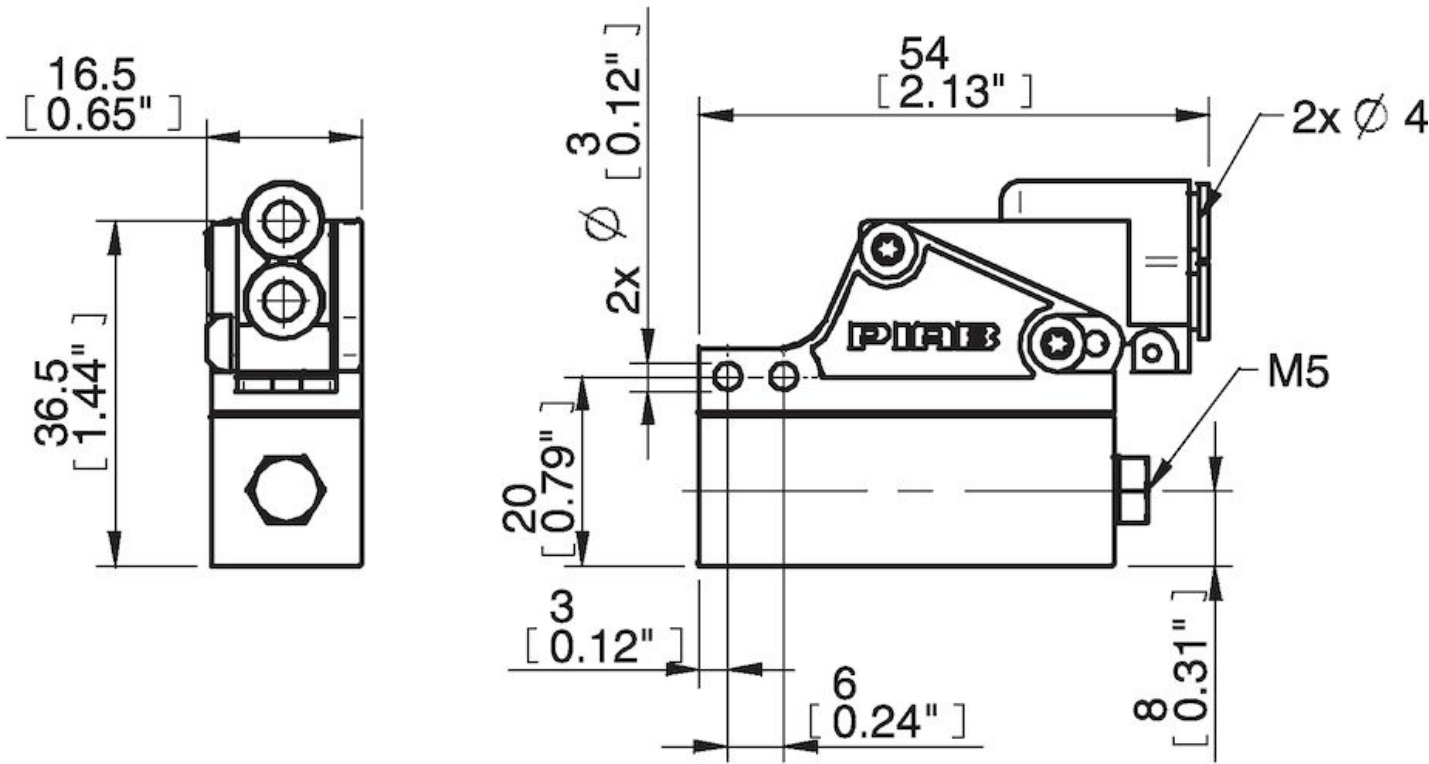
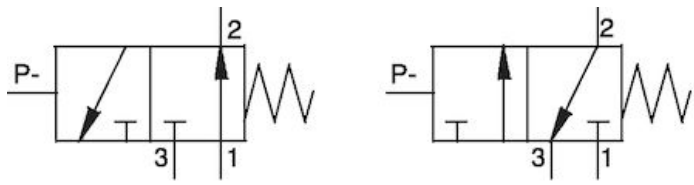

Accessories

01.00.488 | Connection set for vacuum switch