

Suction cup VL75BL, 1/4"NPT-1/8"NPSF

Item number: 02.02.760



- Suitable for level adjustment
- Lifting movement to separate small and thin objects
- Less suitable when the lifting force is parallel to the surface of the object
- Volume discounts available for big packs from 30-99 pieces with an even larger discount for big packs of 100 pieces and above
- PVC-free recycable material

Technical data

Description	Unit	Value
Suction cup shape	-	Multibellows
Suction cup design	-	Round
Material	-	TPE
Suction cup model	-	BL
Height (B)	in	3.65
Height 2 (D)	in	0.71
Inner diameter (C)	in	0.47
Outer diameter, min. (A)	in	2.95
Fitting size	-	1/4", 1/8"
Fitting option	-	None
Fitting style	-	Female/Male
Fitting type	-	NPT-thread, NPSF-thread
Suction cup model	-	VL75BL TPE-U

Performance - Lifting forces

VL75BL TPE-U	Vertical (lb)	Parallel (lb)
14.76 -inHg	17.086 N	

Material

Name	TPE-U
Color	Purple
Temperature, min. °F	32.0
Temperature max. °F	140.0
Hardness °Shore A	65

Material resistance

Alcohol	n/a
Concentrated acids	n/a
Ethanol	n/a
Hydrolysis	n/a
Methanol	n/a
Oil	n/a
Oxidation	n/a
Gasoline	n/a
Wear resistance	n/a
Weather and ozone	n/a

Dimensional drawings

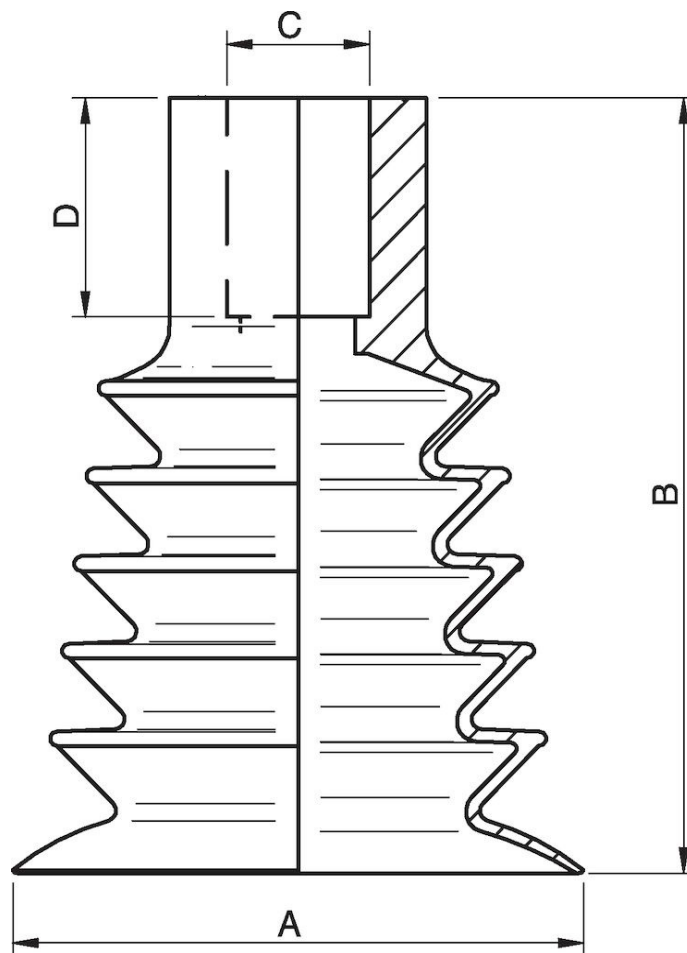

Values specified in this data sheet are tested at (unless otherwise stated):

- Room temperature (20°C [68°F] ± 3°C [5.5°F]).
- Standard atmosphere (101.3 [29.9 inHg] ± 1.0 kPa [0.3 inHg]).
- Relative humidity 20-70%.
- Compressed air quality, DIN ISO 8573-1 class 4.

Accessories

- 02.02.159 | Fitting VL D=Ø12, G1/4" - G1/8"
- 02.02.165 | Fitting VL D=Ø12, G3/8" - G1/4"
- 02.02.167 | Fitting VL D=Ø12, 3/8" NPT - 1/4" NPSF

Spare parts

- 02.02.163 | Fitting VL D=Ø12, 1/4"NPT - 1/8"NPSF
- 02.02.123 | Suction cup VL75BL