

Suction cup VL50BL, 3/8"NPT-1/4"NPSF

Item number: 02.02.737



- Suitable for level adjustment
- Lifting movement to separate small and thin objects
- Less suitable when the lifting force is parallel to the surface of the object
- Volume discounts available for big packs from 30-99 pieces with an even larger discount for big packs of 100 pieces and above
- PVC-free recycable material

Technical data

Description	Unit	Value
Suction cup shape	-	Multibellows
Suction cup design	-	Round
Material	-	TPE
Suction cup model	-	BL
Height (B)	in	2.46
Height 2 (D)	in	0.59
Inner diameter (C)	in	0.39
Outer diameter, min. (A)	in	1.97
Fitting size	-	3/8", 1/4"
Fitting option	-	None
Fitting style	-	Female/Male
Fitting type	-	NPT-thread, NPSF-thread
Suction cup model	-	VL50BL TPE-U

Performance - Lifting forces

VL50BL TPE-U	Vertical (lb)	Parallel (lb)
14.76 -inHg	7.87 N	

Material

Name	TPE-U
Color	Purple
Temperature, min. °F	32.0
Temperature max. °F	140.0
Hardness °Shore A	65

Material resistance

Alcohol	n/a
Concentrated acids	n/a
Ethanol	n/a
Hydrolysis	n/a
Methanol	n/a
Oil	n/a
Oxidation	n/a
Gasoline	n/a
Wear resistance	n/a
Weather and ozone	n/a

Dimensional drawings

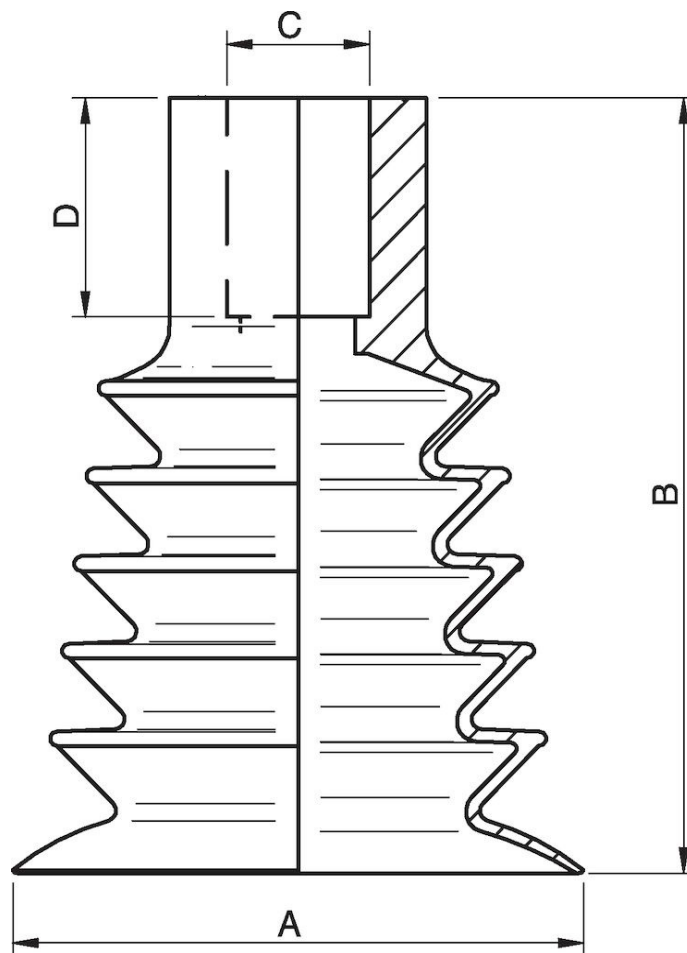

Values specified in this data sheet are tested at (unless otherwise stated):

- Room temperature (20°C [68°F] ± 3°C [5.5°F]).
- Standard atmosphere (101.3 [29.9 inHg] ± 1.0 kPa [0.3 inHg]).
- Relative humidity 20-70%.
- Compressed air quality, DIN ISO 8573-1 class 4.

Accessories

- 02.02.158 | Fitting VL D=Ø10, G1/4" - G1/8"
- 02.02.164 | Fitting VL D=Ø10, G3/8" - G1/4"
- 02.02.162 | Fitting VL D=Ø10, 1/4" NPT - 1/8" NPSF

Spare parts

- 02.02.166 | Fitting VL D=Ø10, 3/8" NPT - 1/4" NPSF
- 02.02.121 | Suction cup VL50BL