

## Suction cup VL50BX

Item number: 02.02.114



- Suitable for level adjustment.
- Several short bellows in one lifting device can handle objects with height differences and varying shapes, for example embossed or corrugated plates
- The lifting movement can be used to separate small and thin objects
- Only light weight objects should be handled when the lifting force is parallel to the surface of the object in order to achieve good precision and safe lifting movement
- Volume discounts available for big packs from 30-99 pieces with an even larger discount for big packs of 100 pieces and above
- PVC-free recyclable material

### Technical data

Description	Unit	Value
Suction cup shape	-	Bellows
Suction cup design	-	Round
Material	-	TPE
Suction cup model	-	BX-P
Height (B)	in	1.72
Height 2 (D)	in	0.59
Inner diameter (C)	in	0.39
Outer diameter, min. (A)	in	1.97
Fitting size	-	None
Fitting option	-	None
Fitting style	-	None
Fitting type	-	None
Suction cup model	-	VL50BX TPE-U

### Performance - Lifting forces

VL50BX TPE-U	Vertical (lb)	Parallel (lb)
14.76 -inHg	9.89 N	

<b>Material</b>	
Name	TPE-U
Color	Purple
Temperature, min.   °F	32.0
Temperature max.   °F	140.0
Hardness   °Shore A	65

**Material resistance**

Alcohol	n/a
Concentrated acids	n/a
Ethanol	n/a
Hydrolysis	n/a
Methanol	n/a
Oil	n/a
Oxidation	n/a
Gasoline	n/a
Wear resistance	n/a
Weather and ozone	n/a

**Dimensional drawings**

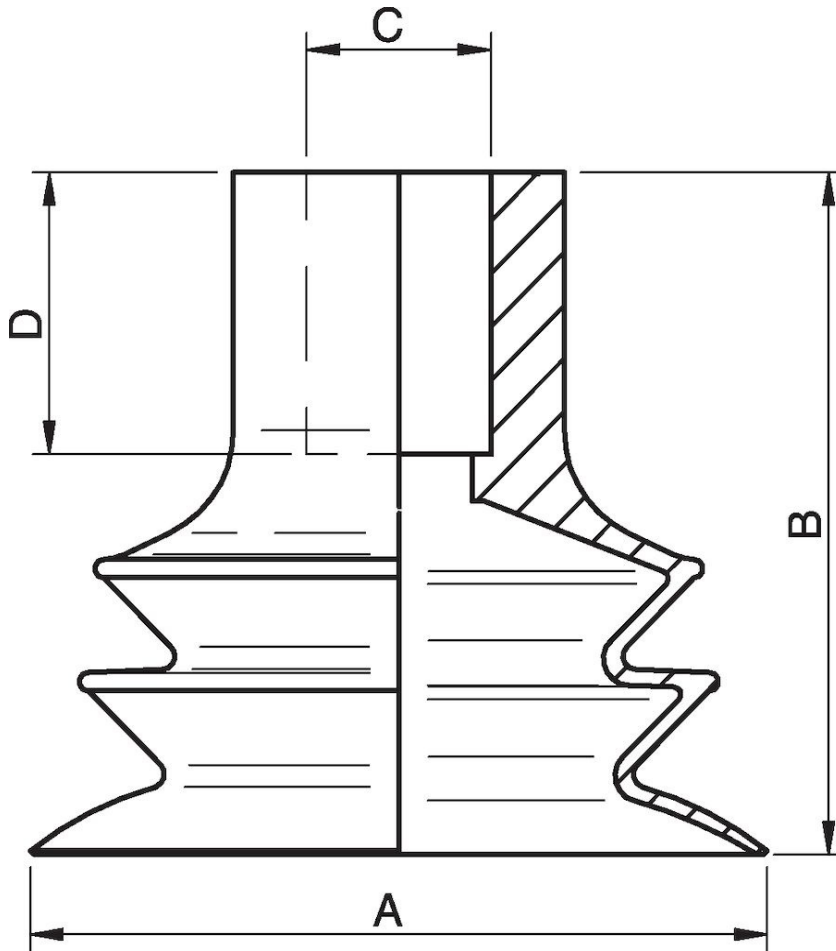

**Values specified in this data sheet are tested at (unless otherwise stated):**

- Room temperature (20°C [68°F] ± 3°C [5.5°F]).
- Standard atmosphere (101.3 [29.9 inHg] ± 1.0 kPa [0.3 inHg]).
- Relative humidity 20-70%.
- Compressed air quality, DIN ISO 8573-1 class 4.

## Accessories

02.02.158 | Fitting VL D=Ø10, G1/4" - G1/8"

02.02.164 | Fitting VL D=Ø10, G3/8" - G1/4"

02.02.162 | Fitting VL D=Ø10, 1/4" NPT - 1/8" NPSF

02.02.166 | Fitting VL D=Ø10, 3/8" NPT - 1/4" NPSF