

Vacuum Switch VS4128 9 -inHg, M12 PNP NO

Item number: 01.10.630



- Pre-set vacuum switch with digital output.
- Durable and compact design with G1/8" 90° angle swivel connection for easy installation.
- VS4118 hardwired enables PNP NO/NC or NPN NO/NC functionality.
- VS4128 suitable for plug in I/Os. Available in PNP NO or NPN NP models.
- Possible to connect several units serially with T-connectors to provide a common output (VS4128 PNP).

Technical data

Description	Unit	Value
Material	-	Al, CuZn, PA, SS
Temperature, max.	°F	185.0
Temperature, min.	°F	-13.0
Weight, min.	oz	0.81
Display	-	LED indicator
Feed pressure, max. (@ vacuum connection)	psi	0.087
Safety classification	-	IP65
Voltage	VDC	24 (12-30)
Valve function	-	NO
Hysteresis	psi	1.16
Signal range, max.	-inHg	10.040
Signal range, min.	-inHg	7.68
Height	in	0.67
Length	in	0.63
Width	in	2.047
Voltage drop, max	VDC	0.055
Current, inductive, max.	A	0.1
Current, resistive, max.	A	0.4

Dimensional drawings

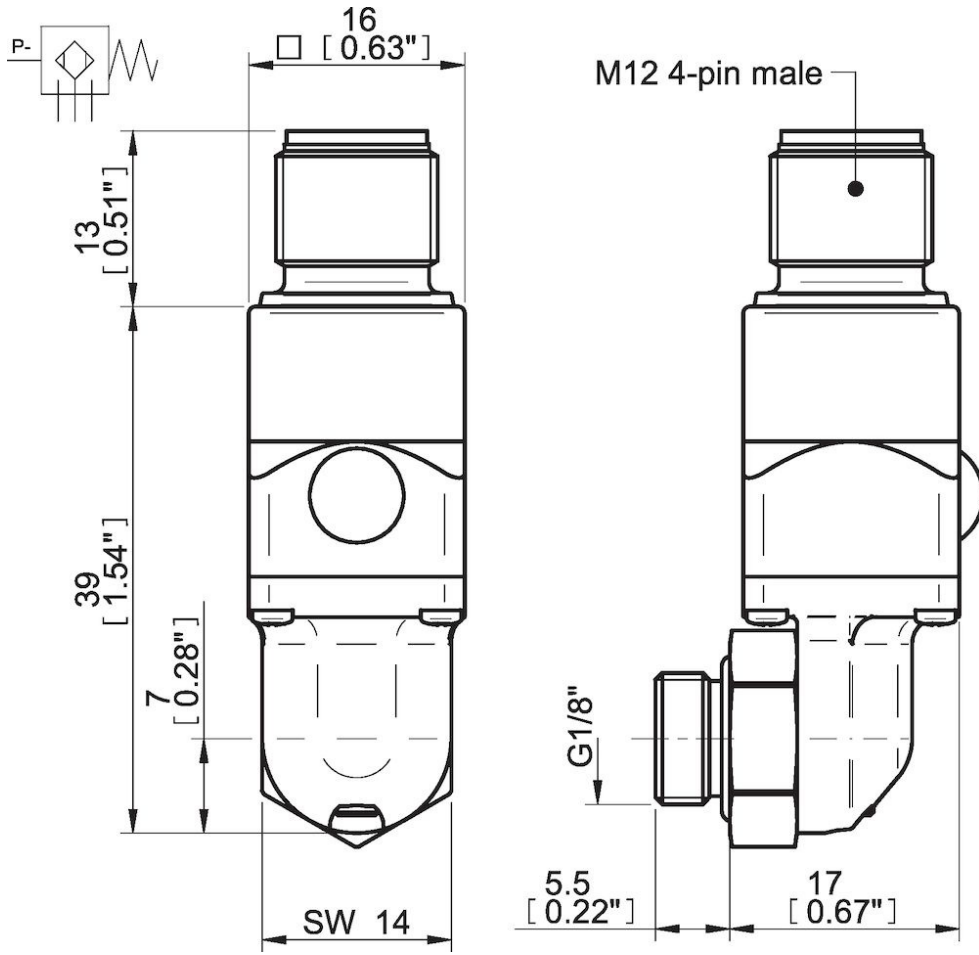

Accessories

01.21.817 | Cable M12 4-pin female, PUR, L=5m*