

Vacuum switch VS4016, G1/8" male, 21.0 -inHg

Item number: 01.10.250



- Pre-set vacuum switch with digital output.
- Very low weight and small format, push-in or thread connections.
- PNP NO/NC or NPN NO/NC output functions.

Technical data

Description	Unit	Value
Material	-	CuZn (Au), PA, SS, Steel, Thermoplastic Polyurethane (TPE-U)
Temperature, max.	°F	185.0
Temperature, min.	°F	-13.0
Weight, min.	oz	0.21
Display	-	LED indicator
Feed pressure, max. (@ vacuum connection)	psi	0.029
Safety classification	-	IP40
Voltage	VDC	24 (12-30)
Valve function	-	NO, NC
Hysteresis	psi	5-9
Signal range, max.	-inHg	22.15
Signal range, min.	-inHg	19.79
Height	in	0.94
Length	in	0.64
Width	in	0.64
Voltage drop, max	VDC	0.055
Current, inductive, max.	A	0.1
Current, resistive, max.	A	0.4

Dimensional drawings

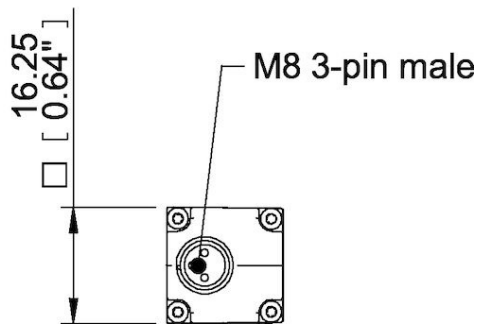
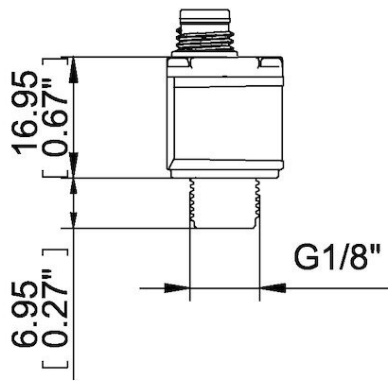
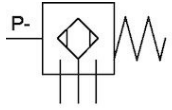

Accessories

01.08.141 | Cable M8 3-pin female L=2m